

52002 QUEEN BED

E1340028, E1340029, E1340030

Components

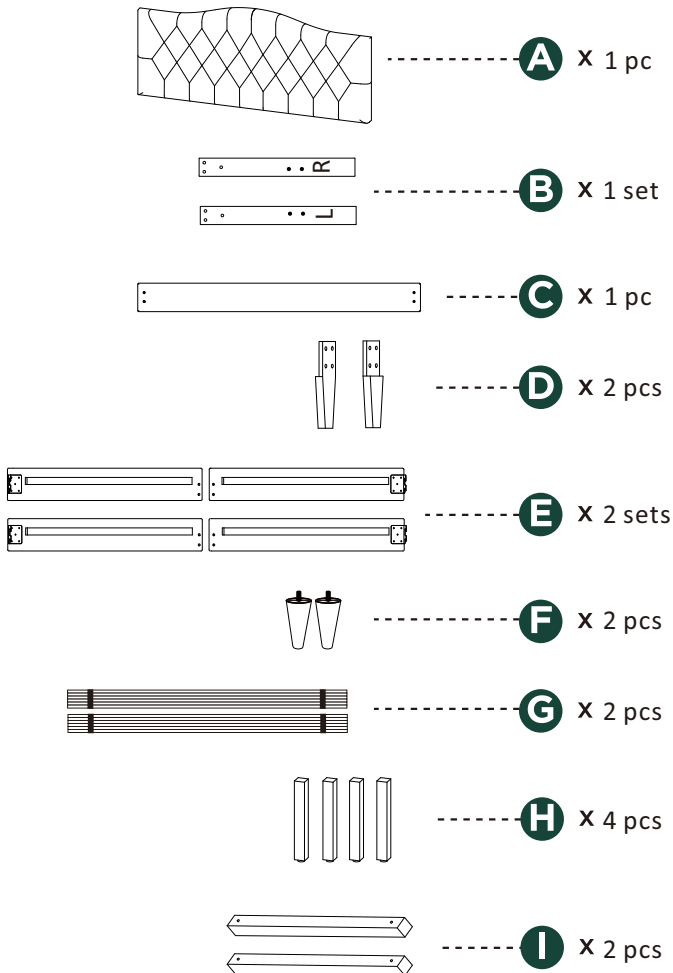

Hardware

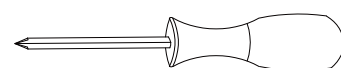
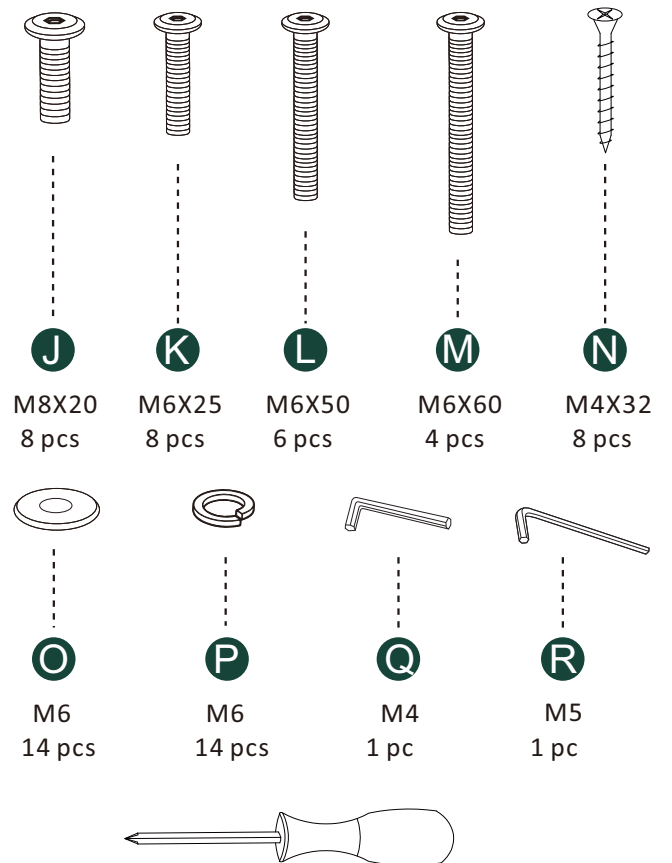

PHILLIPS SCREWDRIVER
REQUIRED
(NOT INCLUDED)

PLEASE CONTACT US FOR RETURNS AND OTHER QUESTIONS

Email our support team at: orders@rizebeds.com

Or call us at: 844-545-8865

Parts are inside the headboard
in the compartment located
on the back of the headboard

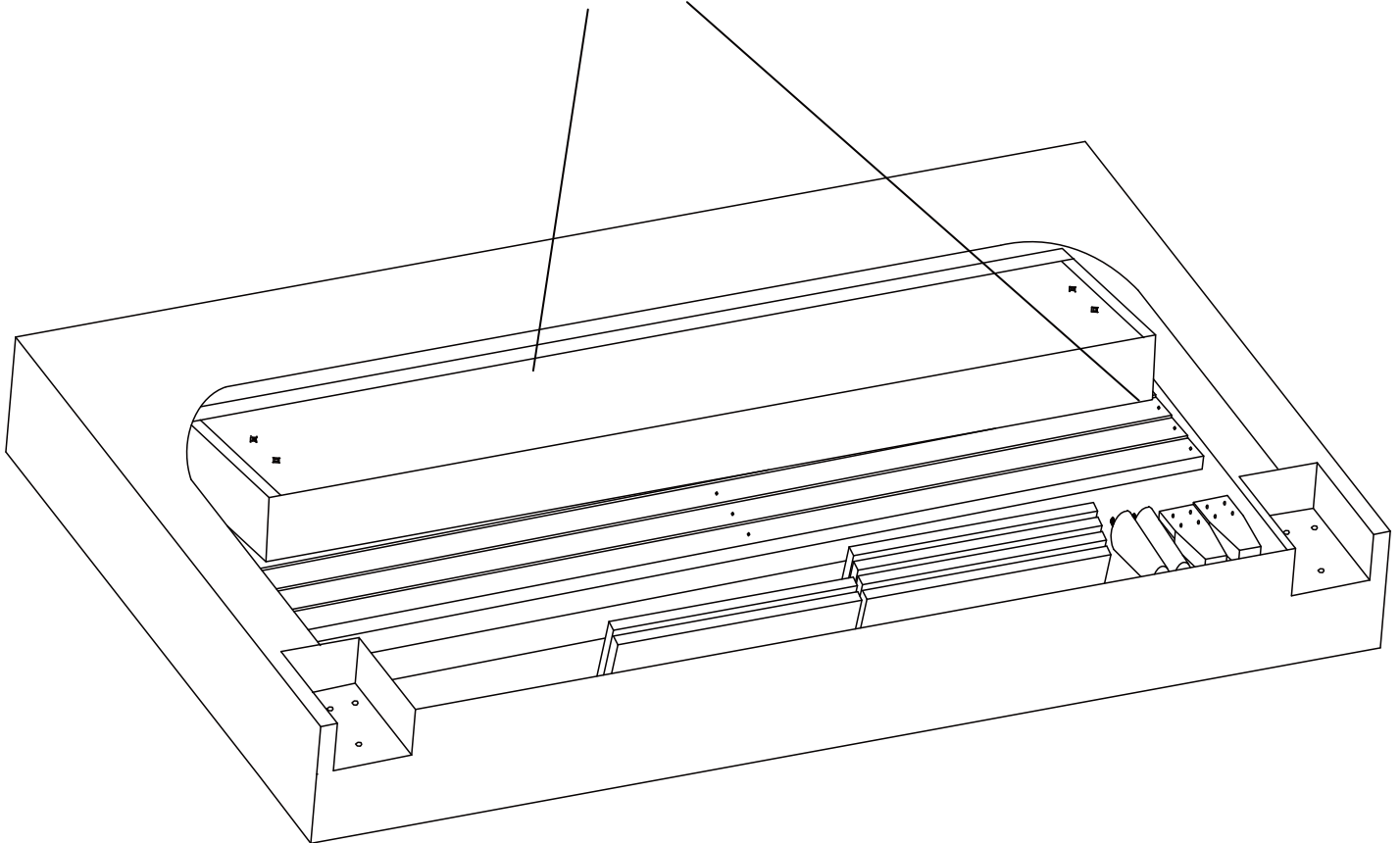

Remove parts from headboard compartment

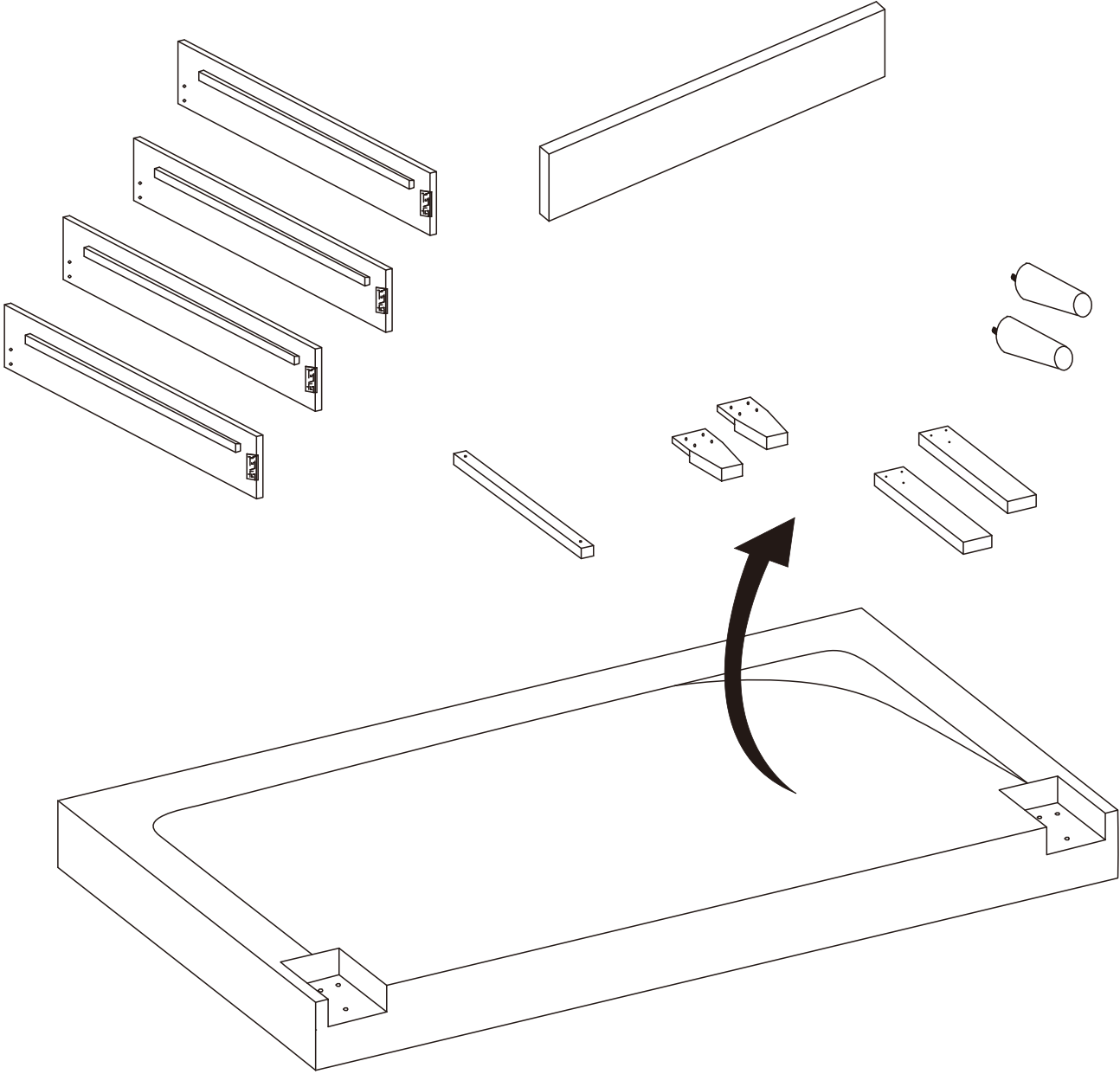

1

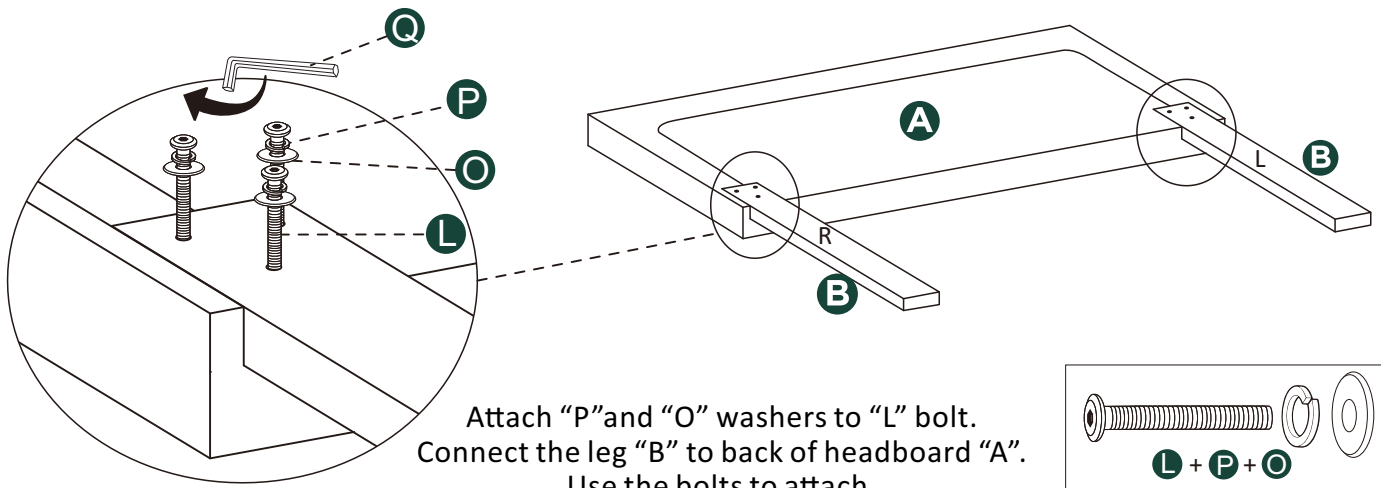

Attach "P" and "O" washers to "L" bolt.
Connect the leg "B" to back of headboard "A".
Use the bolts to attach.

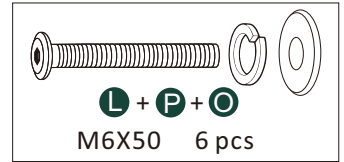

2

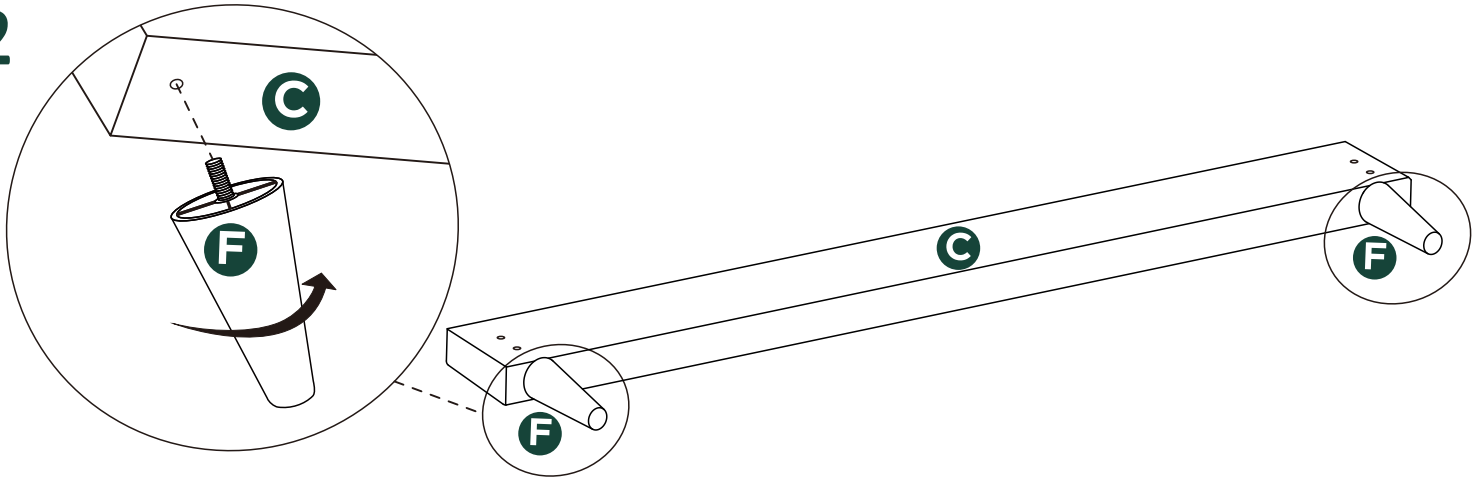

3

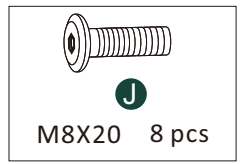
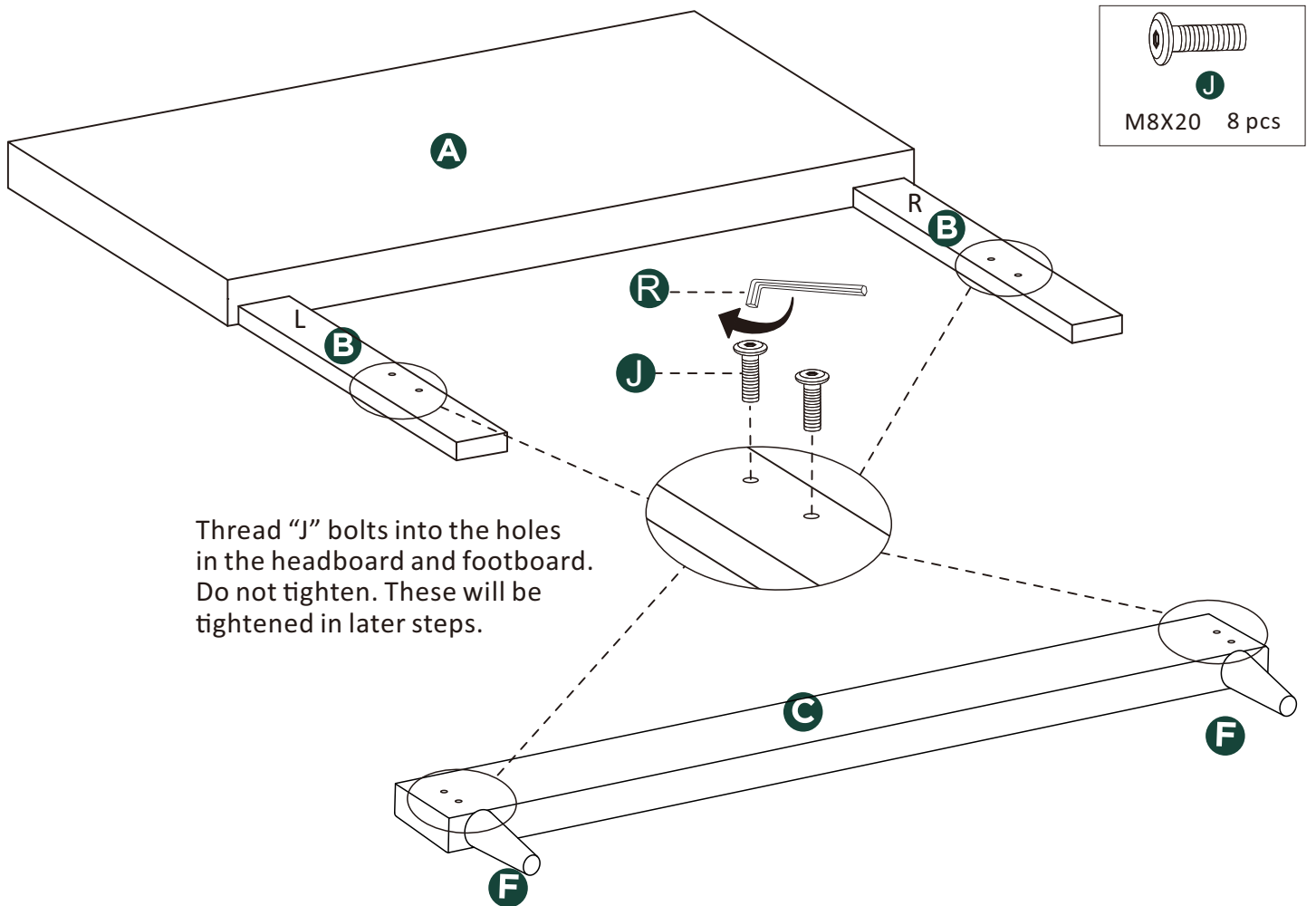

Thread "J" bolts into the holes
in the headboard and footboard.
Do not tighten. These will be
tightened in later steps.

4

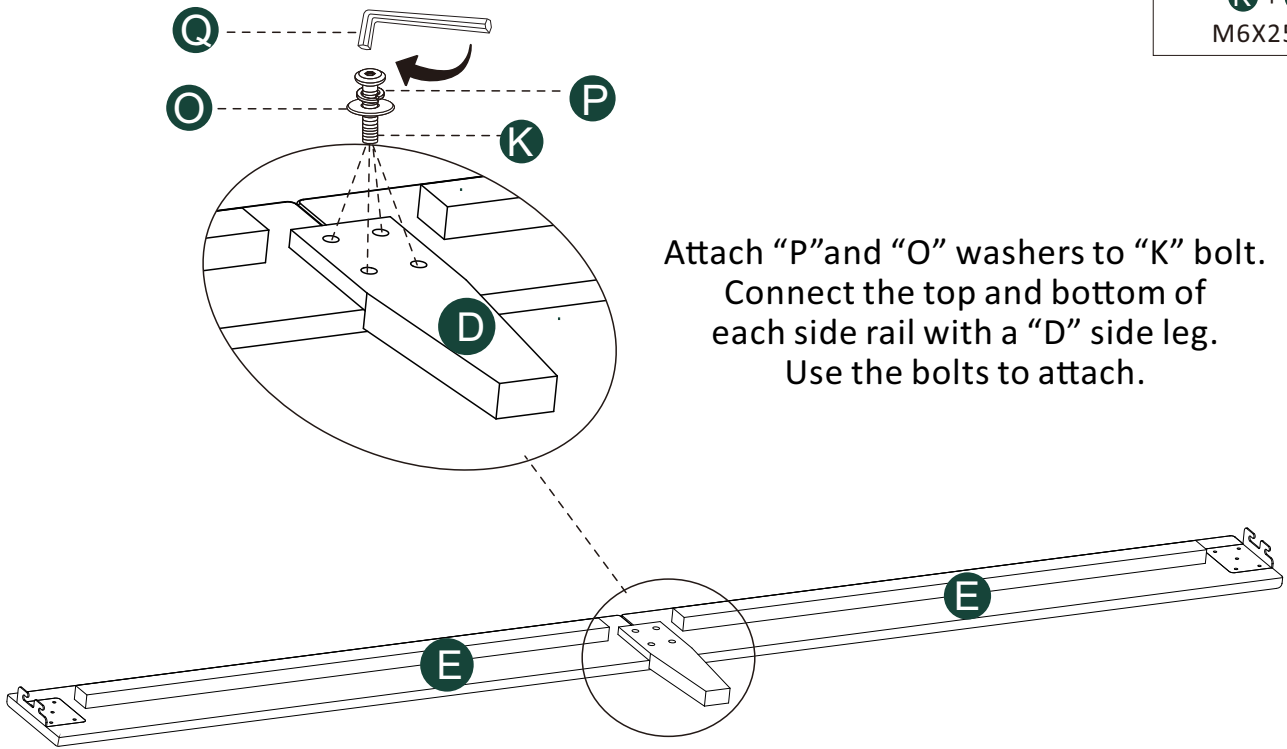
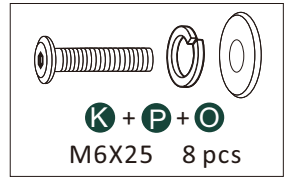

Attach "P" and "O" washers to "K" bolt.
Connect the top and bottom of
each side rail with a "D" side leg.
Use the bolts to attach.

5

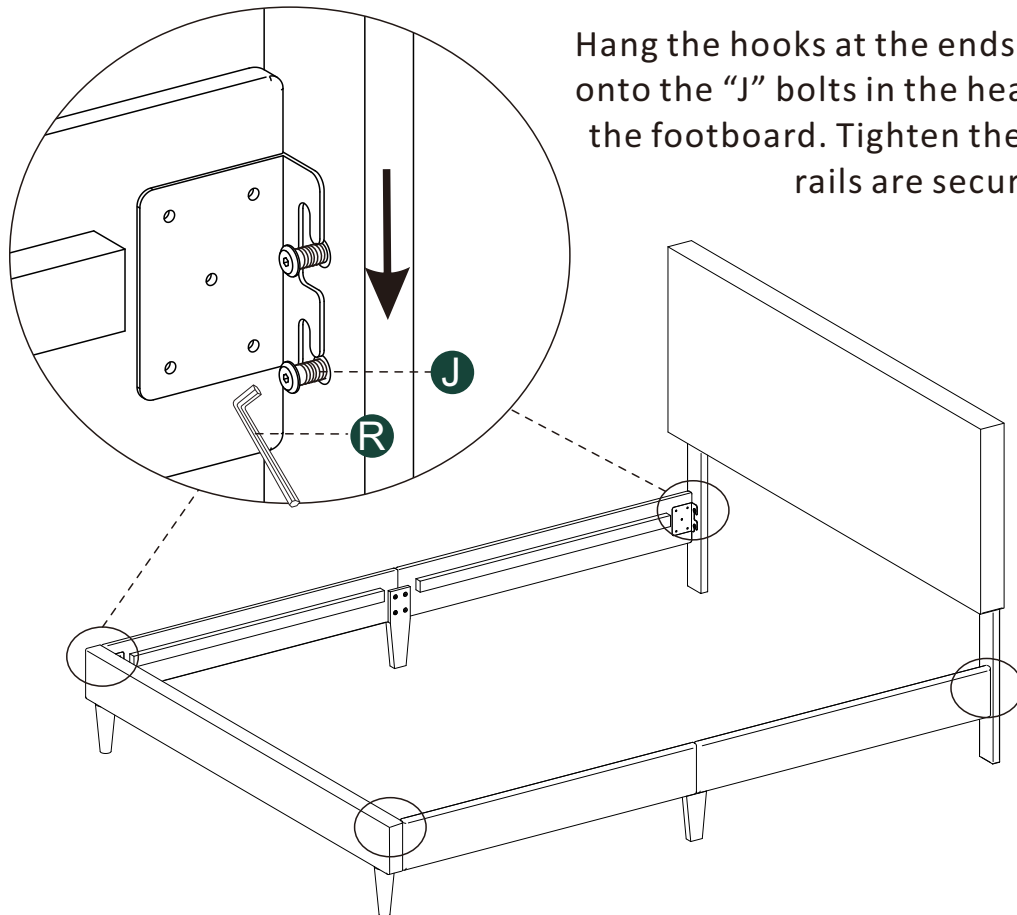

Hang the hooks at the ends of the side rails
onto the "J" bolts in the headboard leg and
the footboard. Tighten the "J" bolt so the
rails are secure.

6

Assemble the slat system by attaching the slats to the "I" supports and "H" legs. First, extend the slats. Then, line up the holes in the slats with the holes in the "I" supports and the holes in the tops of the "H" legs. Use an "M" bolt through the holes to attach them together.

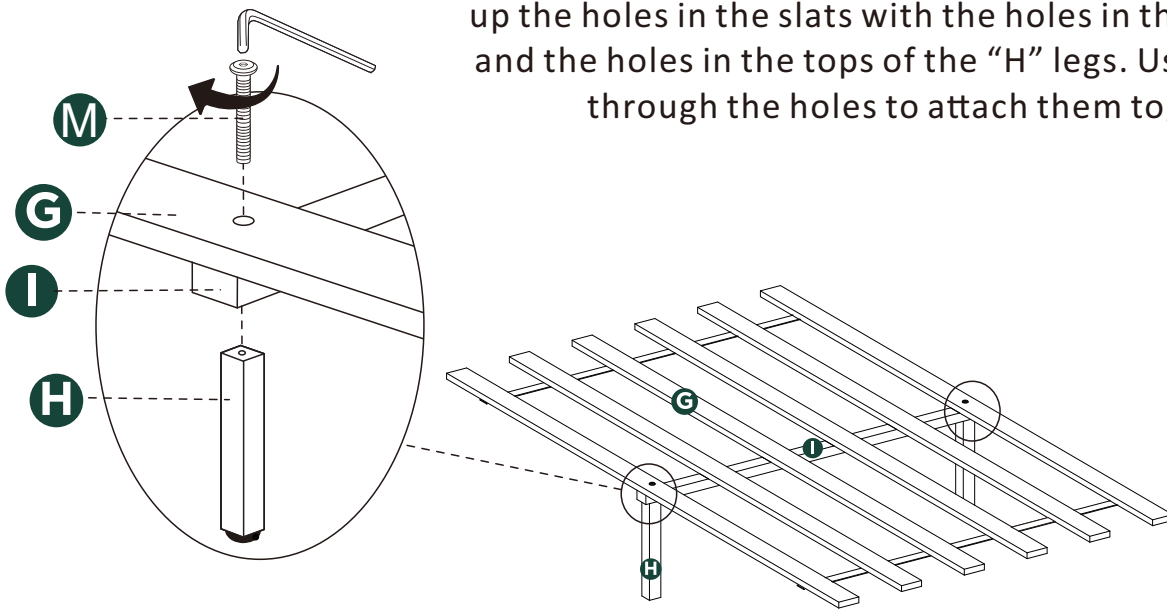

After the slat system is assembled, place the slats into the frame of the bed as shown below.

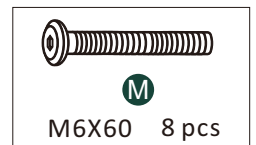

7

Use screwdriver to install "N" screws into side rail cleat

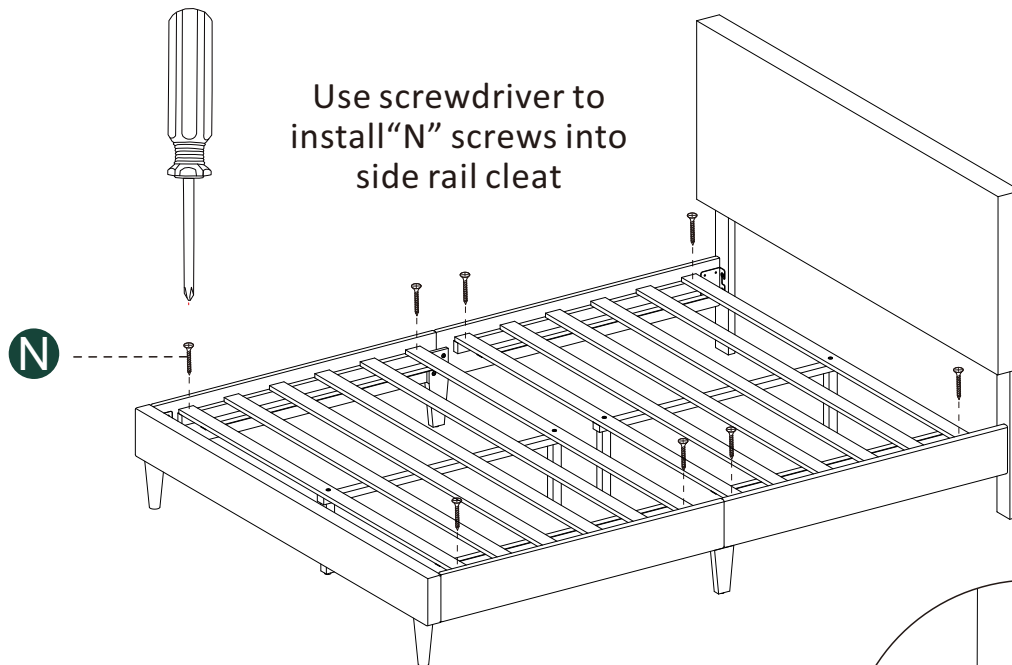

Finally, adjust slat leveling feet to touch floor

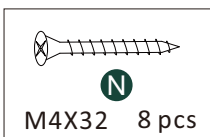
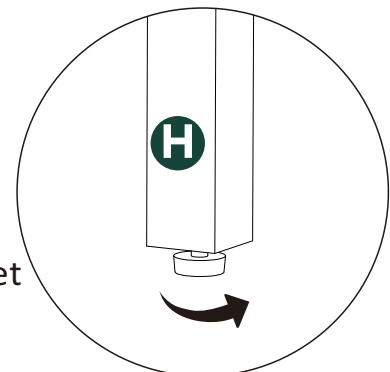

FOR ADDITIONAL HELP:

Contact our support team at: orders@rizebeds.com

Or call us at: 844-545-8865

CAUTION:

Do not attempt to move the bed when fully assembled. This could result in damage to the rails, headboard, or footboard.

When placing furniture on non-carpeted flooring, we recommend the use of floor protection such as an area rug or furniture pads. Area rugs and padding not included with purchase.